

KIT TORNILLOS CALIPER

Ref.: 17280310

Equivalente a:

SAF 3434365600



KIT TONILLERIA PINZA SK7 4T.

Ref.: 17284508

Equivalente a:

SAF 3434366000



RODAMIENTO AGUJAS

Ref.: 17B05038



KIT ACCESORIOS PASTILLA B TS2 3709/4309

Ref.: 17B05044

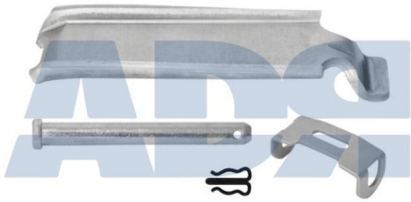

PORTA PINZAS BPW TSB3709/4309 C/PIN

Ref.: 17B05300

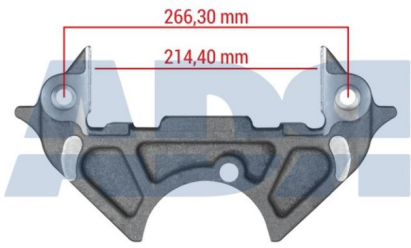

KIT EMPUJADOR

Ref.: 17B05574

MECANISMO DE AJUSTE S/PIN TSB3709/4309

Ref.: 17B11950

Características:

- Peso: 32 gr



MECANISMO PINZA C/PISTON Y TAPA TSB3709/4309 S/PIN

Ref.: 17B12170

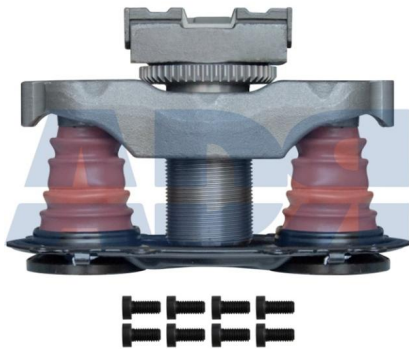

KIT GUIAS Y JUNTAS TSB3709/4309

Ref.: 17B13730

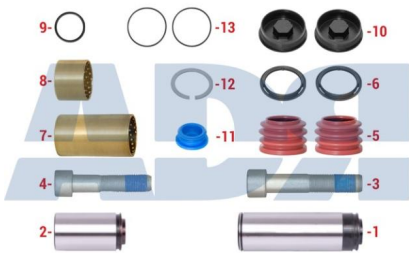

KIT REPARACION (TAQUE) TSB3709/4309

Ref.: 17B13741



RODAMIENTO AGUJAS TSB3709/4309

Ref.: 17B13750



MECANISMO PINZA COMPLETO C/LEVA TSB3709/4309

Ref.: 17B14480



KIT LEVA TSB3709/4309

Ref.: 17B14810



KIT TAPONES TSB3709/4309

Ref.: 17B14960

Características:

- Peso: 30 gr



KIT FIJACION PASTILLAS TSB3709/4309

Ref.: 17B18230



MECANISMO PINZA C/PISTON Y TAPA TSB3709/4309 NEW

Ref.: 17B21860

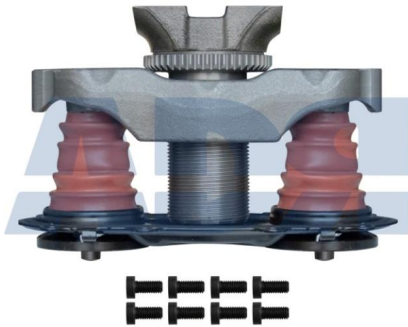

KIT REP RODAMIENTO AGUJAS B TS2 3709/4309

Ref.: 17B24700



KIT TAPON B TS2 4309 (10 UNIDADES)

Ref.: 17B24710



KIT TAPON B TS2 4309 (5 UNIDADES)

Ref.: 17B24720



KIT GUIAS Y JUNTAS B TS2 3709/4309

Ref.: 17B24730

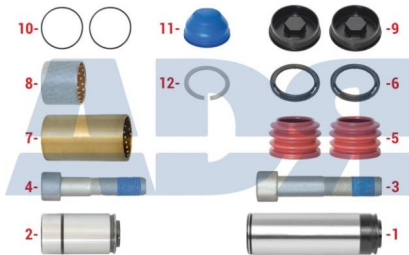

MECANISMO AJUSTE B TS2 3709/4309

Ref.: 17B24740

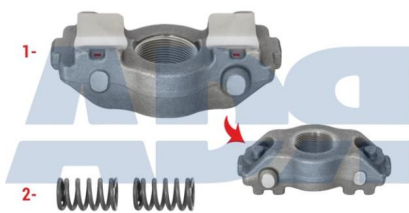



Saf

KIT LEVA CALIPER 4309 (S2)

Ref.: 17B24750



BULON CALIBRACION ROSCADO B TS2 3709/4309

Ref.: 17B24760



MECANISMO DE REPARACION B TS2 3709/4309

Ref.: 17B24770



KIT TAPA DERECHA CALIPER B TS2 3709/4309

Ref.: 17B24810



KIT TAPA IZQUIERDA CALIPER B TS2 3709/4310

Ref.: 17B24820



KIT LEVA CALIPER B TS2 3709

Ref.: 17B24870





Saf

KIT TAPAS PROTECCION

Ref.: 17H06025



LEVA MARK IV

Ref.: 17H11570

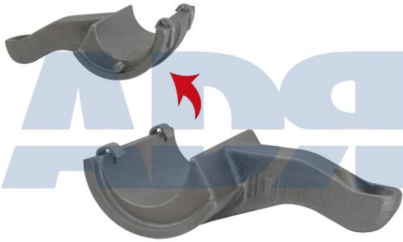

RODAMIETO AGUJAS MARK IV

Ref.: 17H12780



PLACA EMPUJE MARK IV

Ref.: 17H12790

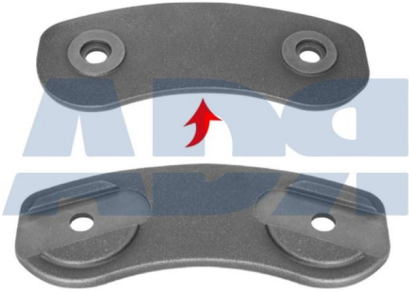

BULON AJUSTE (VERSIÓN PLACA EMPUJE) MARK IV

Ref.: 17H12800



BULON AJUSTE (VERSIÓN PISTÓN) MODUL X GEN 2

Ref.: 17H12810



ARANDELA DENTADA MODUL X GEN 2

Ref.: 17H12900



MECANISMO AJUSTE MODULX GEN2

Ref.: 17H12920



RODAMIENTO AGUJAS MODUL X GEN2

Ref.: 17H13200

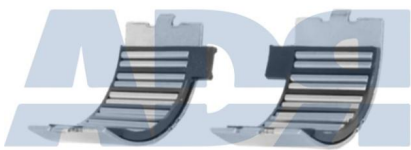

KIT RODAMIENTO AGUJA MODUL X GEN 2

Ref.: 17H13210

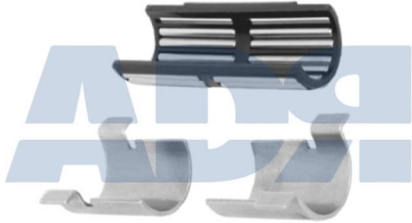

KIT GUARDAPOLVOS Y MUELLES MODUL X GEN 2

Ref.: 17H13350



PUENTE DE MONTAJE C/MUELLE MODUL X GEN 2

Ref.: 17H13450

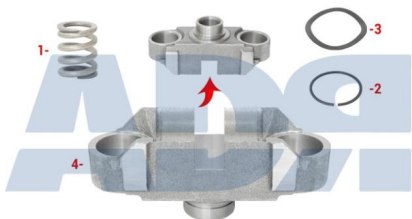

GRAPA MECANISMO MODUL X GEN 2

Ref.: 17H13470

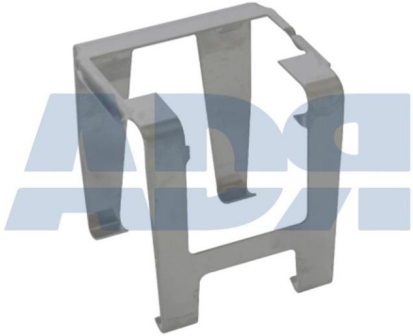

PIÑÓN AJUSTE DENTADO MARK IV

Ref.: 17H13480

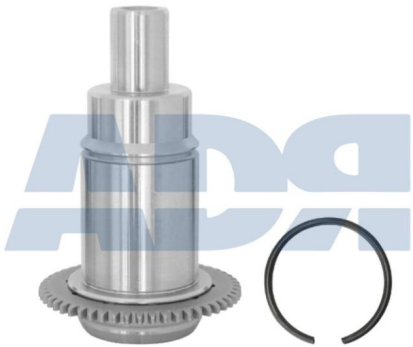

MANGA AJUSTE DENTADA MARK IV

Ref.: 17H13490



KIT BULON AJUSTE Y RETEN MARK IV

Ref.: 17H13500



KIT GUIAS Y JUNTAS MARK IV

Ref.: 17H13510

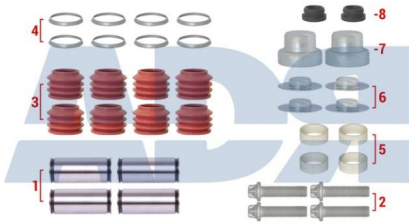

KIT GUIAS Y JUNTAS MARK IV

Ref.: 17H13520

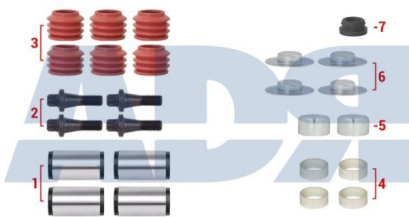



SAF

KIT GUIAS Y JUNTAS X-GEN 2 TIPO

Ref.: 17H13530



MECANISMO AJUSTE MARK IV

Ref.: 17H14100



TAPA CALIPER MODUL X GEN 2

Ref.: 17H14190

Características:

- Peso: 960 gr

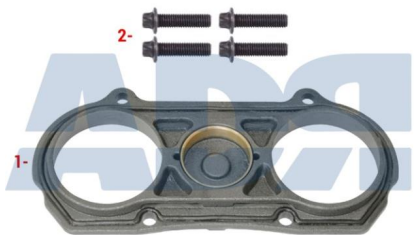

CJTO. MECANISMO C/TAPA ALUMINIO MODUL X GEN 1

Ref.: 17H14221

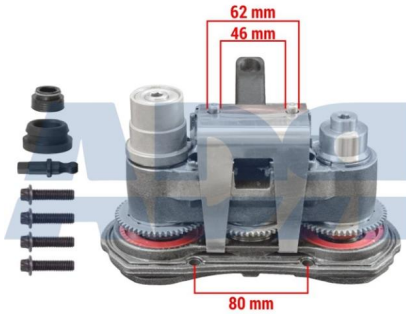

PLACA SUJECCION PASTILLAS MARK IV

Ref.: 17H14250



MECANISMO PINZA C/PISTON Y TAPA MODUL X GEN 2

Ref.: 17H14360



KIT GUARDAPOLVOS MARK IV

Ref.: 17H14380

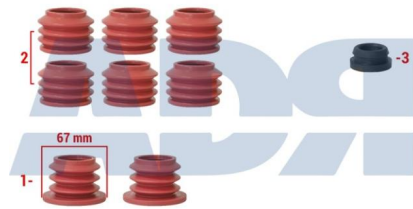

KIT GUIAS Y JUNTAS MARK II-III

Ref.: 17H14550

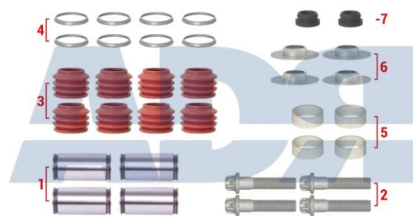

KIT GUIAS Y CIERRE (TAPA METAL) MODUL T SAF SBS2220

Ref.: 17H14560

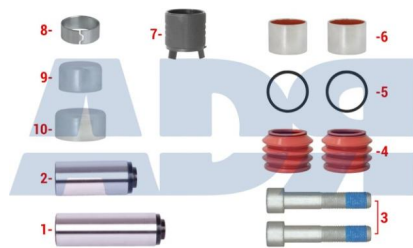

KIT 5 CASQUILLOS PLAST. AJUSTADOR MODUL T (SAF) SBS2220

Ref.: 17H14600



KIT ARANDELAS DENTADAS MODUL T (SAF) SBS2220

Ref.: 17H14620

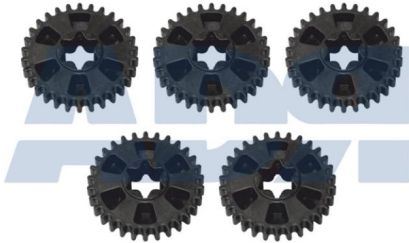

TAPA CALIPER MARK II-III

Ref.: 17H14630

Características:

- Peso: 1290 gr

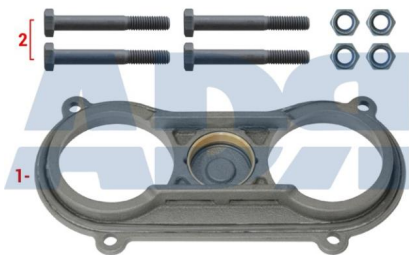

KIT (10) TAPONES PLASTICO MODUL T (SAF) SBS2220

Ref.: 17H14700

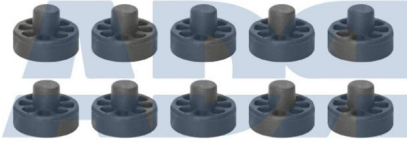

KIT TAPONES PLASTICO MODUL T (SAF) SBS2220

Ref.: 17H14710

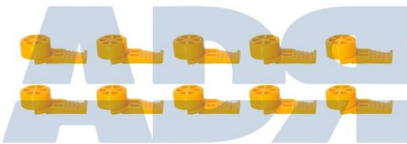

MECANISMO C/PISTON Y TAPA MARK IV

Ref.: 17H14880

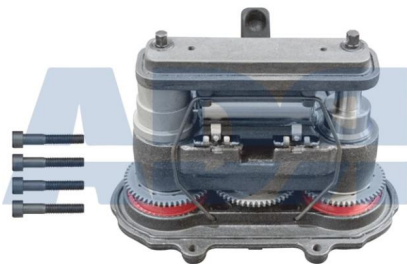

RODAMIENTO AGUJAS HALDEX SBS2220

Ref.: 17H18050

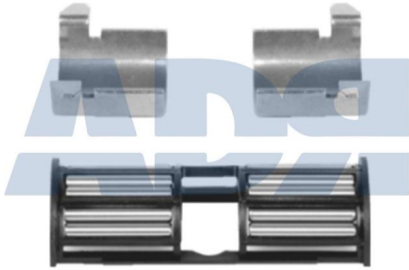

KIT MECANISMO MODUL T (SAF) SBS2220

Ref.: 17H18140

PLASTIC ITEM IS FOR PROTECTION.
IT SHOULD NOT BE USED FOR ASSEMBLY



KIT CALIPER COMPLETO MODUL T (SAF) SBS 2220

Ref.: 17H18160



KIT FIJACION PASTILLAS MODULT SAF SBS2220

Ref.: 17H18240



KIT EMPUJADORES MARK II-III Ø73 MM

Ref.: 17H18290



MECANISMO PISTON Y CARCASA MARK II-III

Ref.: 17H18350

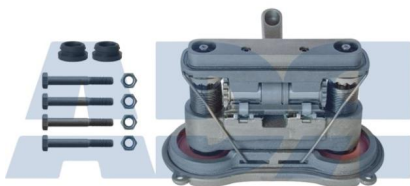

TAPA MODUL X GEN 1

Ref.: 17H18640

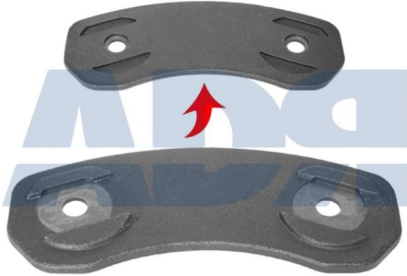

KIT REPARACION MARK II / III

Ref.: 17H19330

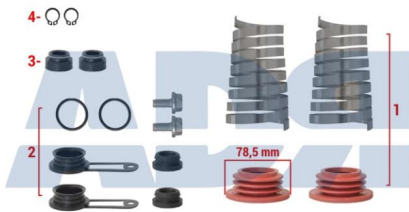

PLACA EMPUJADORA MODUL T (SAF) DBB22LT (JOST)

Ref.: 17H23820



CONJUNTO HALDEX MODUL T (SAF) DBT22LT (JOST)

Ref.: 17H23830



RETENEDOR DE PASTILLAS DE FRENO DTB22LT VERSION 2

Ref.: 17H24910



CASQUILLO BRONCE Ø40XØ36X82

Ref.: 17K06521

Características:

- Peso: 99 gr



SENSOR 3 CABLES PARA MERCEDES

Ref.: 17K06587

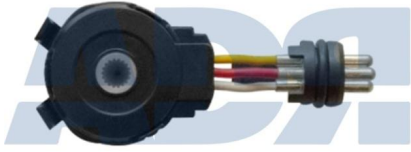

SENSOR 3 CABLES PARA MAN TGA

Ref.: 17K06588

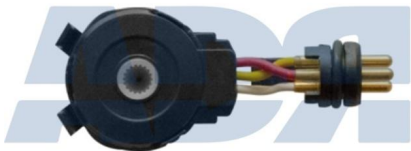

KIT EMPUJADORES K SB5

Ref.: 17K11010

Características:

- Diámetro exterior: 69,300 mm
- Peso: 195 gr

Equivalente a:

MAN 81508226027

MERCEDES-BENZ A0004204282,
0004204282



KIT GUIAS Y CIERRE K SB5 (FUELLE)

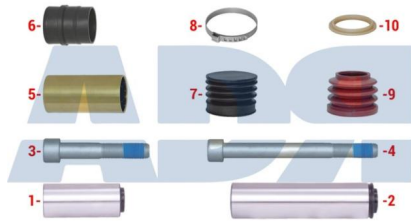

Ref.: 17K11020

Características:

- Peso: 1990 gr

Equivalente a:

BPW 0980102870, 0980102610

DAF 1448915, 1142142, 1198153,
1198154

EVOBUS 6274200150

FRUEHAUF M100918, LSA0086001

IVECO 5801109377, 93162048

MAN 81508226009, N1011014128

MERCEDES-BENZ A0501211763,
A0004203015, A0004201282,
A0014202883, 0014202883,
0501211763, 0004201282,
0004203015

NEOPLAN 11015565

RENAULT TRUCKS 5021133459,
5021135225

SAF 5317002100, 05317002100

SCANIA 2121643, 1390427

SCHMITZ CARGOBULL 1052335,
015418

KIT GUIAS Y CIERRE K SB6/SB7 (TAPA METALICA)

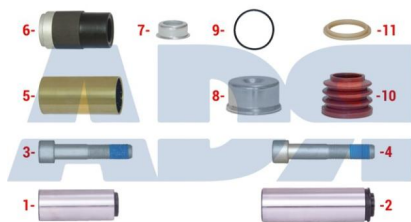

Ref.: 17K11030

Características:

- Peso: 1495 gr

KIT REPARACION CALIPER

Ref.: 17K11040

Características:

- Peso: 570 gr

Equivalente a:

DAF 1439494

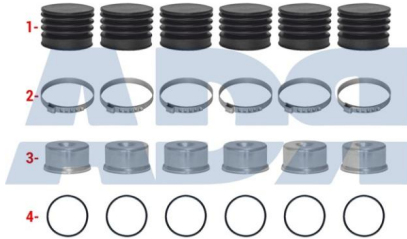
FRUEHAUF M100977-----
IVECO 5006028068-----
MAN 81508226025-----
MERCEDES-BENZ A0501211048,
0501211048-----
NEOPLAN 11015473-----
RENAULT TRUCKS 5021175294-----
SAF 05317002700, 5317002700-----
SCANIA 2121839**RODAMIENTO AGUJAS K SB6/SB7/SN6/SN7/SK7**

Ref.: 17K11050

**CADENA 14 ESLABONES**

Ref.: 17K11070



BULON CALIBRACION K SB5/SB6/SB7/SN6/SN7/SK7

Ref.: 17K11080



TAPA CALIPER C/SENSOR 2 CABLES K SN5

Ref.: 17K11090

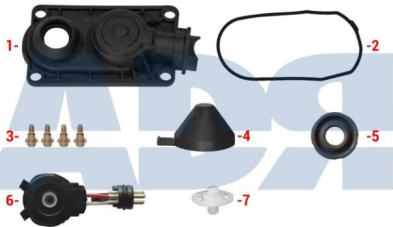

PIÑON DE AJUSTE S/MUELLE K SL7/SM7

Ref.: 17K11120

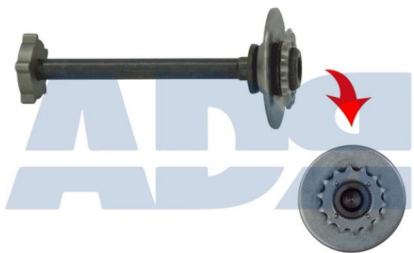

MECANISMO DE AJUSTE K SB5

Ref.: 17K11130

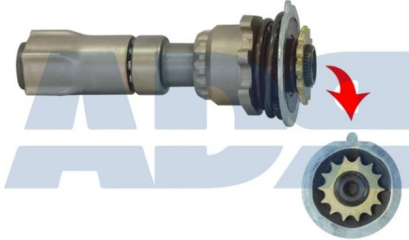

PUENTE ROSCADO GUIA C/MUELLE K SB5

Ref.: 17K11140

Características:

- Peso: 900 gr

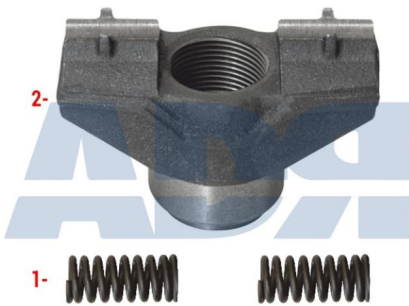

KIT EMPUJADORES Ø74MM K SB5/SB6/SB7

Ref.: 17K11160

Características:

- Diametro: 68 mm
- Lado de montaje: eje trasero
- Peso: 647 gr

Equivalente a:

BPW 09.801.02.63.0, 0980102630

 MAN 81508226022, 81.50822.6007,
 81508226007, 81.50822.6022

 MERCEDES-BENZ A000 420 0682,
 A000 420 3982, A000 420 4882,
 A0004200682, A0004203982,
 A0004204882, 000 420 0682, 000 420
 3982, 000 420 4882, 0004200682,
 0004203982, 0004204882

 SAF 3.434.3804.00, 3434380400

 SCANIA 1746824, 1759811, 1390429

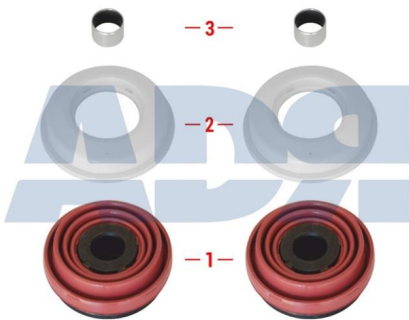

TAPA C/TORNILLOS K SN6/SN7/SK7/SM7



Ref.: 17K11190

Características:

- Peso: 451 gr

KIT GUIAS Y CIERRE K SB6/SB7 (FUELLE)

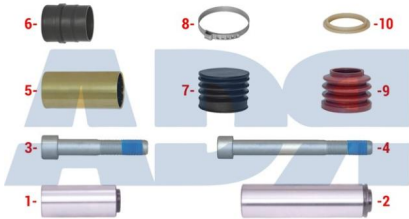

Ref.: 17K11250

Características:

- Peso: 1900 gr

Equivalente a:

BPW 0980102510

IVECO 97131442, 97131439

MAN 36508226008, 81508226005

MERCEDES-BENZ A0004201082,
A0004202182, 0004201082,
0004202182

NEOPLAN 82135301

RENAULT TRUCKS 5021175206

SCANIA 1798063, 2121644

SCHWARZMULLER 106820

KIT GUIAS Y CIERRE K SB6/SB7 (TAPA METALICA)

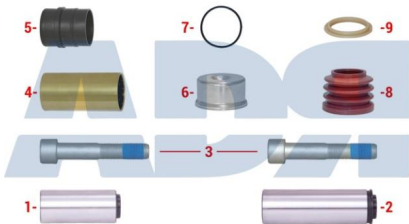

Ref.: 17K11270

Características:

- Peso: 1620 gr

Equivalente a:

IVECO 42537451

MECANISMO DE AJUSTE K SB6/7/SN6/S7/SL7/SM7/SK7

Ref.: 17K11290

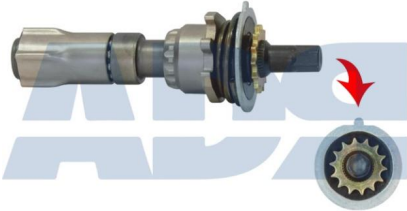

MECANISMO DE AJUSTE K SN6/SN7/SK7

Ref.: 17K11292

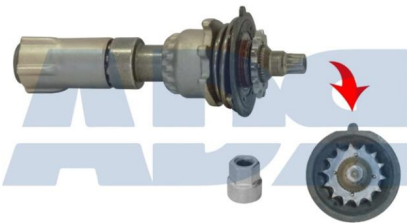

PIÑON AJUSTE C/MUELLE K SB6/7/SN6/7/SK7

Ref.: 17K11300

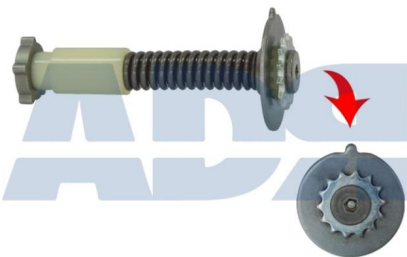

MECANISMO DE AJUSTE K SM7

Ref.: 17K11301

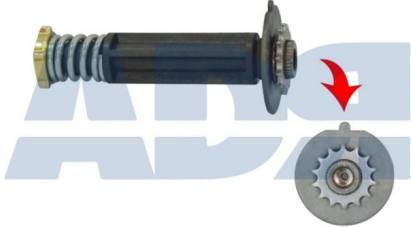

CADENA 29 ES LABONES K SB6/7/SN6/S7/SL7/SM7/SK7

Ref.: 17K11310



PUENTE ROSCADO GUIAS K SB6/SB7

Ref.: 17K11320

Características:

- Peso: 2000 gr

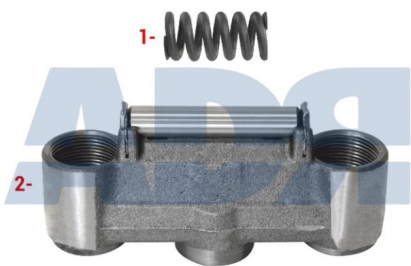

TAPA CALIPER C/SENSOR 2 PINS K SB6/7/SN6/S7/SL7/SM7/SK7

Ref.: 17K11330

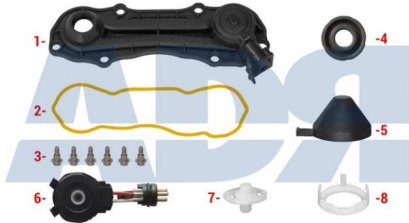

TAPA CALIPER S/SENSOR K SB6/SB7/SM7

Ref.: 17K11331



TAPA CALIPER C/SENSOR 3 CABLES K SB6/SB7

Ref.: 17K11332

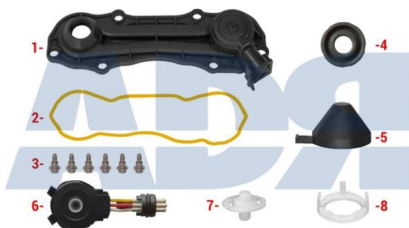

TAPA CALIPER C/SENSOR 3 CABLES K SN6/SN7/SK7

Ref.: 17K11333

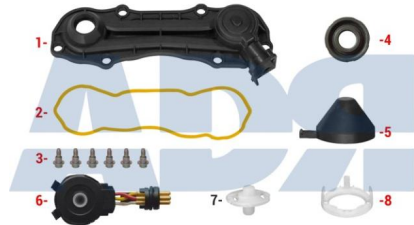

LEVA (ANGULO 0° - 114 MM) K SB6/SB7

Ref.: 17K11350



LEVA (ANGULO 12° - 123 MM) K SB6/SB7

Ref.: 17K11360

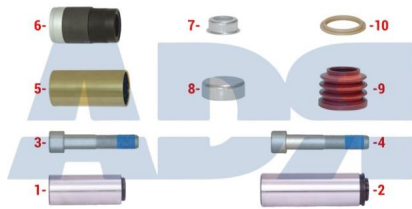

KIT GUIAS Y CIERRE K SN6/SN7/SK7 (TAPA METALICA)

Ref.: 17K11390

Características:

- Peso: 1540 gr

Equivalente a:

BPW 09.801.06.33.0, 0980106330

 KOGEL 6500508

 SAF 3.434.3812.00, 3434381200

 SCANIA 1723416

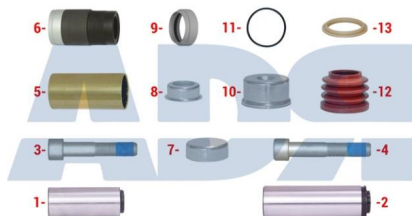
KIT GUIAS Y JUNTAS K SB6/SB7

Ref.: 17K11391

Características:

- Peso: 1495 gr

Equivalente a:

BPW 0980106310, 09.801.06.31.0

 IVECO 42541412, 42537451, 4253
 7451, 4254 1412

 MAN 81508226043, 81508226036,
 81508226023, 81.50822.6043,
 81.50822.6036, 81.50822.6023

 MERCEDES-BENZ 000 420 2982,
 A0004202982, A000 420 2982,
 0004202982

 SAF 3434382000, 3.434.3820.00

 SCANIA 2365038, 1477676

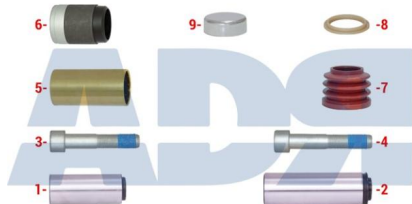
KIT GUIAS Y CIERRE K SB6/SB7/SL7/SN6/SN7/SK7/SM7

Ref.: 17K11400

Características:

 - Lado de montaje: eje trasero
 - Peso: 1436 gr

Equivalente a:

DAF 1847716, 2169198, 1639100

 MAN 81.50822.6019, 81.50822.6034,
 81.50822.6037, 81.50822.6044,
 81508226019, 81508226034,
 81508226037, 81508226044

 MERCEDES-BENZ A002 420 0383,
 A0024200383, A000 420 4682, 000
 420 4682, 0024200383, 002 420
 0383, 0004204682, A0004204682

 SCANIA 527631, 1527631, 1477675

PUENTE ROSCADO GUIAS K SN6/SN7/SK7/ST7

Ref.: 17K11410

Características:

- Peso: 2000 gr

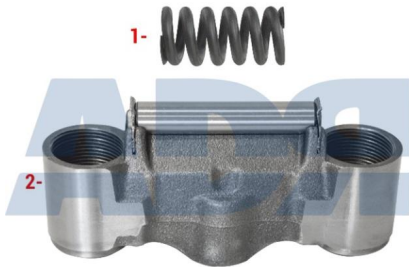

PUENTE ROSCADO GUIAS K SN6/SN7/SK7/SL7/SM7

Ref.: 17K11420

Características:

- Peso: 1700 gr

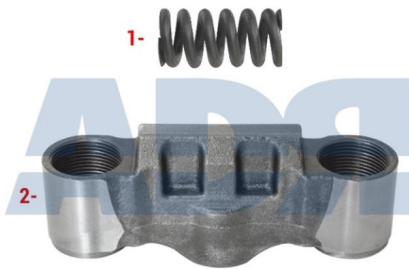

LEVA (ANGULO 0° - 124 MM) K SN6/SN7/SK7

Ref.: 17K11430



LEVA (ANGULO 0° - 113 MM) K SN6/SN7/SK7

Ref.: 17K11440



LEVA (ANGULO 0° - 127 MM) K SB6/SB7

Ref.: 17K11441



LEVA (ANGULO 0° - 113 MM) K SN6/SN7/SK7

Ref.: 17K11442



LEVA (ANGULO 12° - 122 MM) K SN6/SN7/SK7

Ref.: 17K11443

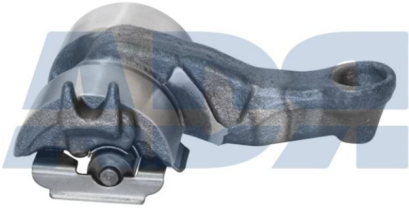

JUNTA TAPA C/TORNILLOS K SN6/SN7/SK7

Ref.: 17K11450

Características:

- Peso: 425 gr



LEVA K SB7 RADIAL

Ref.: 17K11460



KIT PUENTE Y JUNTA DE TAPA K SN5

Ref.: 17K11590

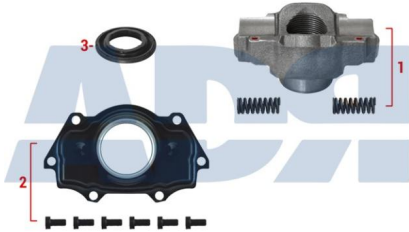

KIT EMPUJADORES K SM7 (Ø69MM)

Ref.: 17K11610

Equivalente a:

Características:

MERCEDES-BENZ A0004230316S1,
0004230316S1

- Peso: 374 gr

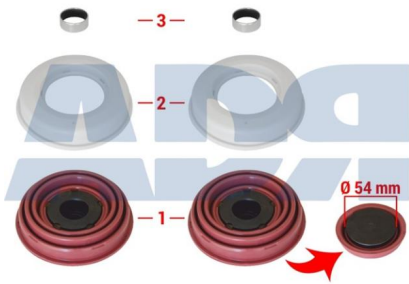

LEVA (124 MM) K SN6/SN7/SK7

Ref.: 17K11630



BULON CALIBRACION K SM7

Ref.: 17K11680



TAPA CALIPER S/SENSOR K SB7 RADIAL

Ref.: 17K11810



TAPA CALIPER C/SENSOR 3 CABLES K SB7

Ref.: 17K11811

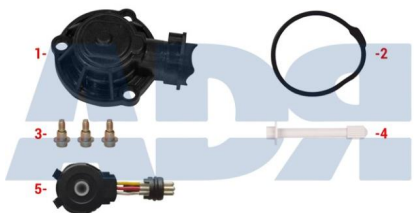

KIT EMPUJADORES K SN6/SN7/SK7 (Ø69MM)

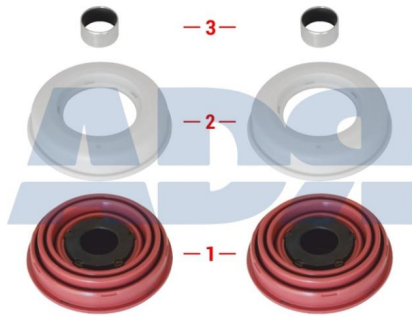

Ref.: 17K12270

Características:

- Diámetro: 65 mm
- Lado de montaje: eje trasero, eje delantero
- Peso: 605 gr

Equivalente a:

BPW 09.801.06.32.0, 0980106320, 0980166320, 09.801.66.32.0

DAF 2169199, 1616894, 1622785, 1689313

KOGEL 6500509

MAN 81508226031, 81508226020, 81.50822.6031, 81.50822.6020

MERCEDES-BENZ A0004204082, A0004202382, A000 420 4082, A000 420 2382, 000 420 2382, 000 420 4082, 0004202382, 0004204082

SAF 3434381400, 3.434.3814.00

SCANIA 1743421, 1756389

KIT GUIAS Y CIERRE K SN6/SN7/SK7 (TAPA METALICA)

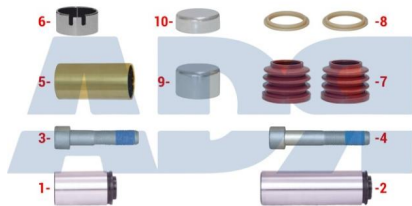

Ref.: 17K12640

Características:

- Peso: 1501 gr

Equivalente a:

SAF 3.434.3815.00, 3434381500

KIT TAPAS PLASTICO Y TORNILLOS AJUSTE K SN6/SN7/SK7/SM7

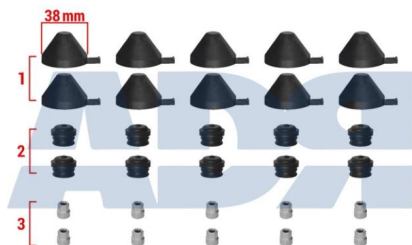

Ref.: 17K12670

Características:

- Peso: 187 gr

Equivalente a:

DAF 1439493

MAN 81508226024, 81508226021, 81.50822.6024, 81.50822.6021

KIT TAPAS Ø35, TAPAS Y TORNILLOS K SB6/SB7/SN6/SN7/SK7

Ref.: 17K12671

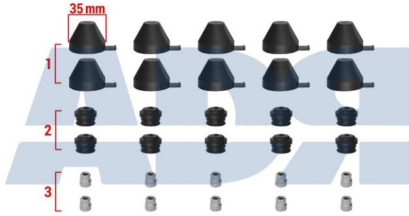

KIT TAPAS PLASTICO Y TORNILLOS AJUSTE K SN6/SN7/SK7/SM7

Ref.: 17K12680

Equivalente a:

Características:

DAF 1439493

- Lado de montaje: eje delantero
- Peso: 187 gr

MAN 81.50822.6021, 81.50822.6024,
81508226021, 81508226024

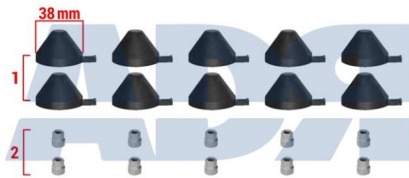

KIT TAPAS Ø35 Y TORNILLO AJUSTE K SN6/SN7/SK7

Ref.: 17K12681

Equivalente a:

Características:

SCHMITZ CARGOBULL 1008543

- Peso: 195 gr

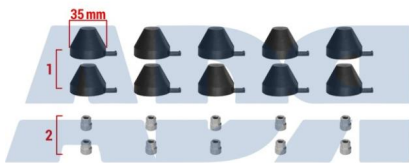

RODAMIENTO AGUJAS K SB5/SB6/SB7



Ref.: 17K12690

Características:

- Altura: 28 mm
- Diámetro exterior: 65 mm
- Diámetro interior: 56,200 mm
- Peso: 163 gr

CADENA 12 ESLABONES K SB5

Ref.: 17K12700



EJE AJUSTE/TENSOR K SN5



Ref.: 17K12870

Características:

- Altura: 43,500 mm
- Diámetro exterior: 29 mm
- Peso: 48 gr

KIT GUIAS Y CIERRE K SN5 (TAPA METALICA)

Ref.: 17K13050

Equivalente a:

Características:

MAN 81508226026

- Peso: 1130 gr

MERCEDES-BENZ 0004204182,
A0004204182



RODAMIENTO AGUJAS K SN5

Ref.: 17K13060



KIT GUIAS Y CIERRE K SN6/SN7/SK75 (TAPA METALICA)

Ref.: 17K13170

Equivalente a:

Características:

MERCEDES-BENZ 0004200782,
0004202282, A0004202282,
A0004202282S, 0004202282S,
A0004200782

- Peso: 2170 gr

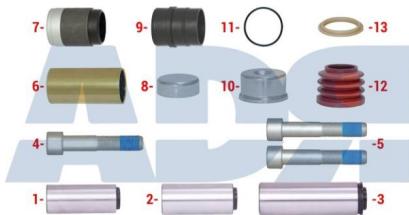

LEVA (ANGULO 12° - 122 MM) K SN6/SN7/SK7

Ref.: 17K13180



KIT CASQUILLO LEVA K SB6/SB7/SN6/SN7/SK7

Ref.: 17K13380



KIT GUIAS Y JUNTAS SB6/SB7

Ref.: 17K13540

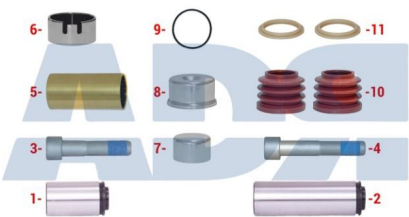

TAPA CALIPER S/SENSOR K SB6/SB7/SN6/SN7/SK7

Ref.: 17K14160

Características:

- Peso: 170 gr



TAPA CALIPER C/SENSOR 3 CABLES K SN6/SN7/SK7

Ref.: 17K14161

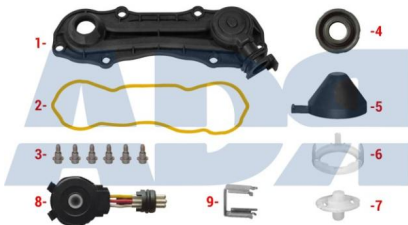

TAPA CALIPER C/SENSOR 2 CABLES K SN6/SN7/SK7

Ref.: 17K14230

Características:

- Peso: 175 gr

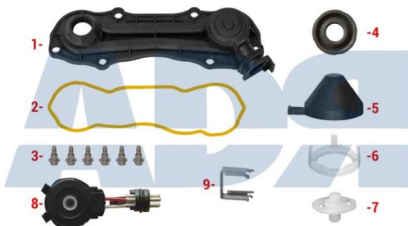

TAPA CALIPER SIN SENSOR SB5

Ref.: 17K14530



TAPA SENSOR 3 CABLES MAN TGL 12-180 K SN5

Ref.: 17K14531



LEVA L122MM K SM7

Ref.: 17K14790



TAPA SENSOR 3 CABLES MERCEDES K SB5

Ref.: 17K14902



TAPA CALIPER C/SENSOR 2 CABLES K SB5

Ref.: 17K14910



KIT GUIAS Y CIERRE K SB6/SB7 (TAPA METALICA)

Ref.: 17K14940

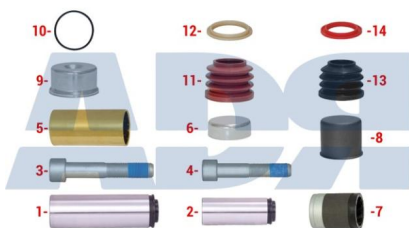

MECANISMO DE AJUSTE K SB5

Ref.: 17K18000



TAPA SENSOR 3 CABLES MERCEDES K SB7 RADIAL

Ref.: 17K18011

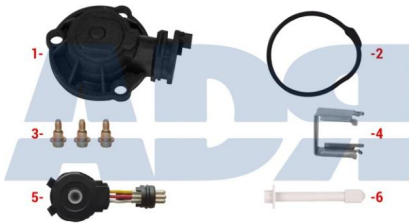

KIT JUNTAS SOPORTE CALIPER K SB5

Ref.: 17K18030

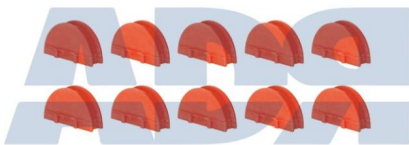

KIT TAPONES K SB5/SB6/SB7/SN5/SN6/SN7/SK7/SM7

Ref.: 17K18040

Características:

- Peso: 113 gr



RODAMIENTO AGUJAS K SL7/SM7

Ref.: 17K18090

Características:

- Peso: 128 gr

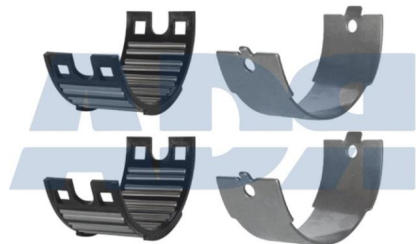

KIT JUNTAS ACTUADOR FRENO Ø42MM K SN6/SN7/SK7

Ref.: 17K19420

Características:

- Peso: 36 gr

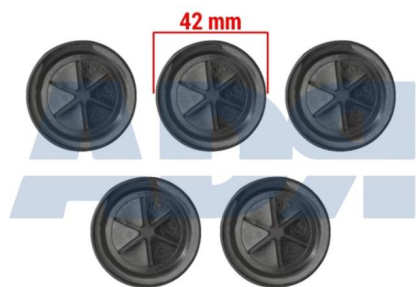

KIT JUNTAS Ø45MM K SN6/SN7/SK7/ST7

Ref.: 17K19430

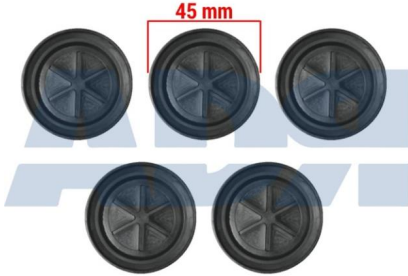

PORTA PINZA KNORR 22,5' (SK7) EJES BPW

Ref.: 17K19510

Equivalente a:

BPW 0130388560

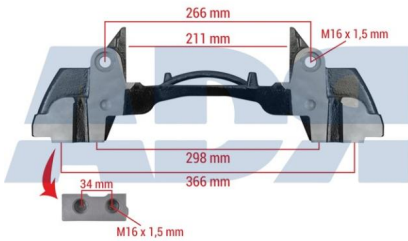

PORTA PINZA K SN6 19,5' BPW, SCANIA

Ref.: 17K19540

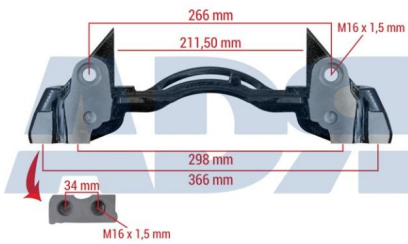

PORTA PINZA K SB7/SN7 (ACTROS & AXOR)

Ref.: 17K19550

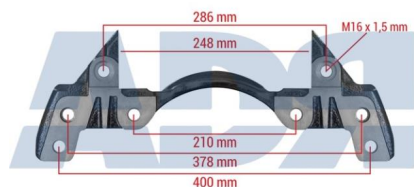

KIT GUIAS K BENDIX IVECO

Ref.: 17K19640

Equivalente a:

Características:

IVECO 93161189

- Peso: 2840 gr

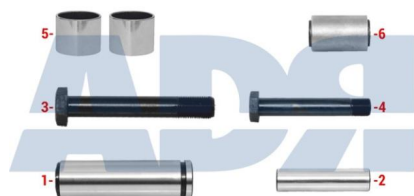

KIT JUNTAS K BENDIX IVECO

Ref.: 17K19650

Equivalente a:

Características:

IVECO 93161192

- Peso: 230 gr



PORTA PINZA K SN5 MAN TGL 12-160

Ref.: 17K19740

Equivalente a:

MERCEDES-BENZ 0004213006,
A0004213006-----
RENAULT TRUCKS 5021171539-----
SCANIA 2121599-----
SCHWARZMULLER 106822**TAPA CALIPER SENSOR 3 CABLES SB7 MAN**

Ref.: 17K19820

**KIT TORNILLOS TAPA K SB5**

Ref.: 17K19910

Características:

- Peso: 635 gr

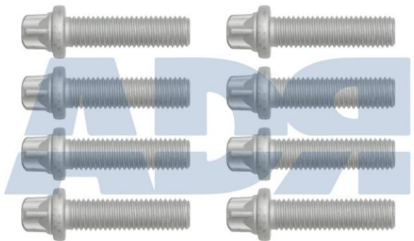

PORTA PINZA KNORR 22,5' (SN7) EJES BPW

Ref.: 17K21300

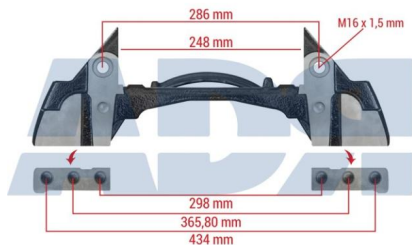

PORTA PINZA KNORR (SAF) SK7

Ref.: 17K21310

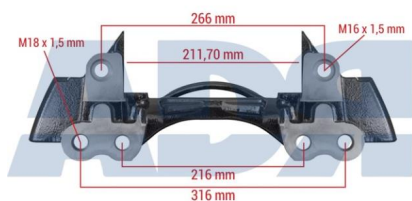

PORTA PINZA 22.5" DRCHO/IZQDO MB

Ref.: 17K21810

PORTA PINZA KNORR SN6 MERCEDES AXOR

Ref.: 17K21820

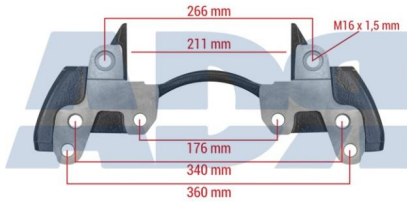

PORTA PINZA KNORR 22,5' (SN7) EJES MERCEDES DISCOS

Ref.: 17K22090

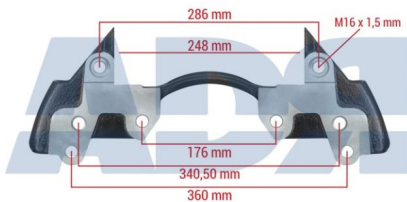

PORTA PINZA KNORR (DAF) SB7/SN7

Ref.: 17K22130

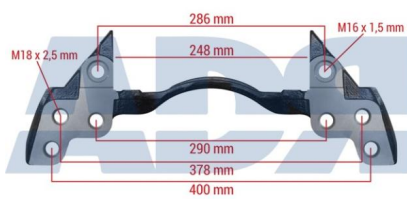

KIT TORNILLOS CALIPER K SB5/SB6/SB7/SL7/SM7/SK7

Ref.: 17K22770

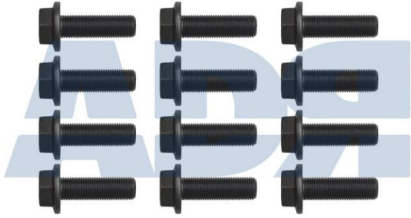

PORTA PINZA KNORR (MERCEDES ATEGO)

Ref.: 17K22860

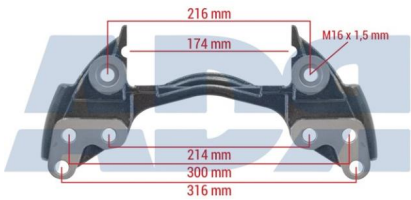

KIT GUIAS Y JUNTAS K SN6/SN7/SK7 (TAPA METALICA)

Ref.: 17K23920

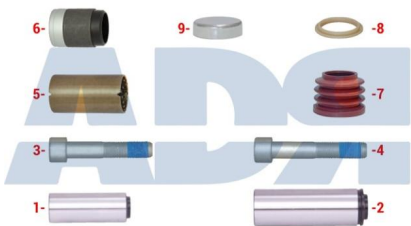

TAPA CALIPER ALUMINIO S/SENSOR K SB6/SB7/SN6/SN7/SK7

Ref.: 17K24200



CASQUILLO GUIA Ø39,5XØ35X76,70 D DUCO RADIAL

Ref.: 17M09530



GUARDAPOLVOS D DUCO RADIAL

Ref.: 17M09582



JUNTA ACTUADOR D DUCO RADIAL

Ref.: 17M09628

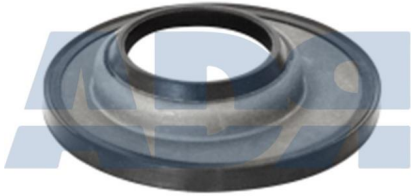

JUNTA PLANA DX195

Ref.: 17M09632

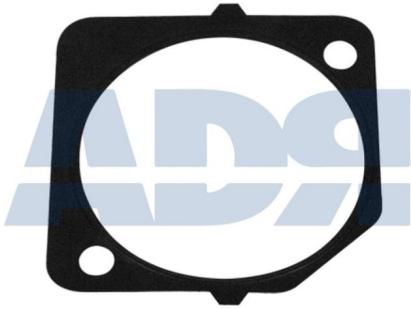

LEVA DERECHA ELSA1 RADIAL/AXIAL

Ref.: 17M11445



KIT REPARACION CALIPER

Ref.: 17M11446

Características:

- Lado de montaje: eje delantero
- Peso: 2320 gr

Equivalente a:

DAF 2169216

MERITOR MCK1298

RENAULT 50 01 866 989,
5001866989

VOLVO 85109890

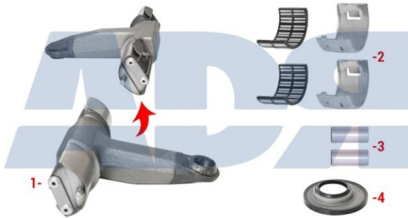

KIT LEVA D DUCO AXIAL TRASERO IZQUIERDO

Ref.: 17M11447

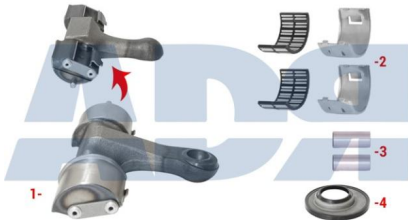

KIT LEVA D DUCO AXIAL TRASERO DERECHO

Ref.: 17M11448

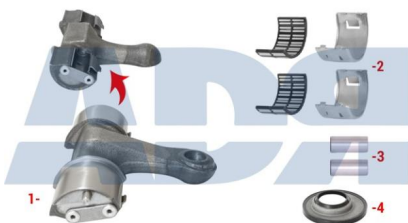

LEVA 114 MM ELSA 195/225/ RADIAL/AXIAL

Ref.: 17M11449

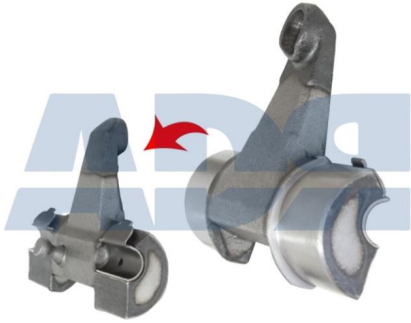

KIT REPARACION CALIPER

Ref.: 17M11470

Características:

- Peso: 154 gr

Equivalente a:

ASTRA 98133544AS

CATERPILLAR 2799674

DAF 1489991

FRUEHAUF CF104388

MERITOR MCK1192

RENAULT TRUCKS 5021170886

SCANIA 1034001

VOLVO AMMCK1192



KIT REPARACION CALIPER

Ref.: 17M11480

Características:

- Peso: 1540 gr

Equivalente a:

MERITOR MCK1171

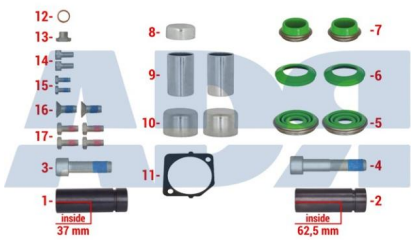

EXCENTRICA C/RODAMIENTOS DX195

Ref.: 17M11490



RODAMIENTO AGUJAS DX195

Ref.: 17M11500

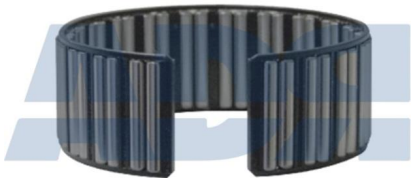

KIT GUARDAPOLVOS DX195

Ref.: 17M11510



KIT JUNTAS ESTANQUEIDAD DX195

Ref.: 17M11520



BULON AJUSTE EXTRIADO IZQUIERDO DX 195

Ref.: 17M11540



BULON AJUSTE EXTRIADO DERECHO DX195

Ref.: 17M11550



KIT LEVA IZQUIERDA C/LE DUCO

Ref.: 17M11650

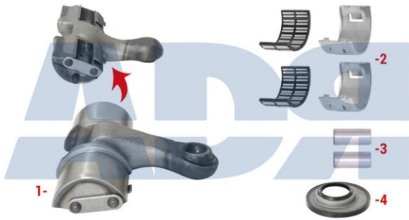

KIT LEVA DERECHA C/LE DUCO

Ref.: 17M11660

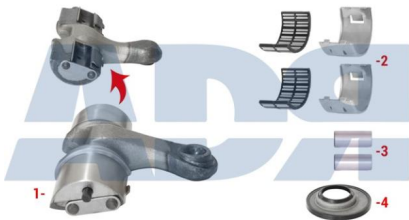

KIT GUIAS Y CIERRE MERITOR ELSA1

Ref.: 17M11670

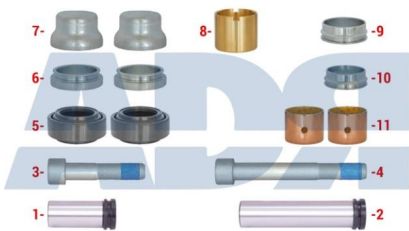

KIT RODAMIENTOS D DUCO AXIAL

Ref.: 17M11700

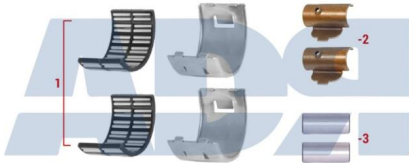

RODAMIENTO AGUJAS D DUCO, ELSA 1, ELSA 2, ELSA 195

Ref.: 17M11710

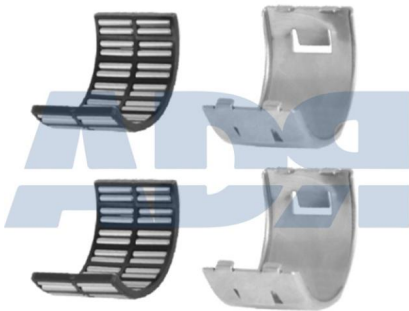

MECANISMO AJUSTE DERECHO ELSA 1

Ref.: 17M11721

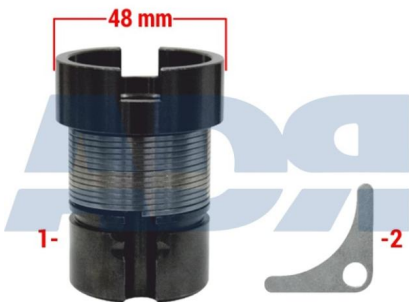

MECANISMO AJUSTE IZQUIERDO ELSA 1

Ref.: 17M11730



KIT PIÑONES AJUSTE DCHO. ELSA 1

Ref.: 17M11770



TAPA DE CIERRE MERITOR ELSA 1

Ref.: 17M11790

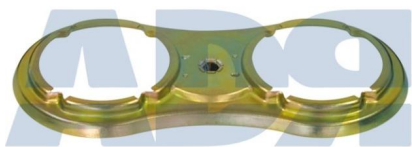

PIÑÓN IZQUIERDO 48 DIENTES CORTO MERITOR D3

Ref.: 17M11900



PIÑÓN IZQUIERDO MONTADO MERITOR D3

Ref.: 17M11960



ARANDELA ONDULADA MERITOR D3

Ref.: 17M12030



KIT GUIAS Y CIERRE D DUCO RADIAL

Ref.: 17M12080

Equivalente a:

Características:

MERITOR MCK1118

- Lado de montaje: eje delantero
- Peso: 1777 gr

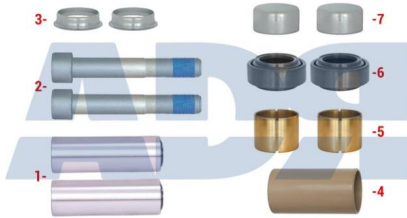
VOLVO 85102092**KIT GUIAS Y JUNTAS D DUCO (GUIA LARGA)**

Ref.: 17M12081

Equivalente a:

Características:

MERITOR MCK1135

- Peso: 1795 gr

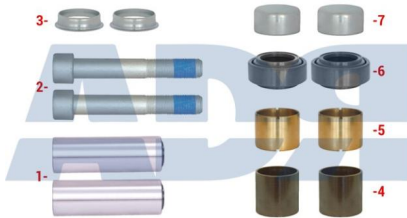
VOLVO 85103891**KIT REPARACION CALIPER**

Ref.: 17M12082

Equivalente a:

Características:

MERITOR MCK1134

- Peso: 1458 gr

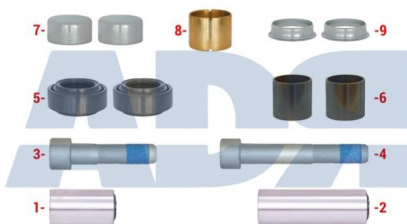
VOLVO 3092255, 85103892

KIT REPARACION CALIPER

Ref.: 17M12090

Equivalente a:

Características:

DAF 2169212

- Lado de montaje: eje trasero
- Peso: 1460,500 gr

MERITOR MCK1116

VOLVO 85102094

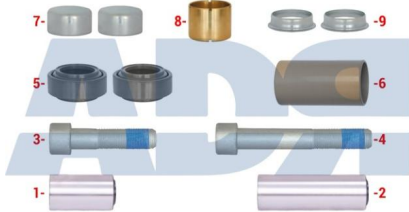

KIT REPARACION CALIPER

Ref.: 17M12110

Equivalente a:

Características:

MAN 81508026027, 81508026024,
81.50802.6027, 81.50802.6024

- Peso: 60 gr

MERITOR MCK1139, 68324854S1,
68324854PK10S1, 68324854PK10
S1, 68324854 S1

VOLVO 20706973 S1, 20706973S1,
20777352 S1, 20777352S1,
85107913, 3092272S1, 3092272 S1

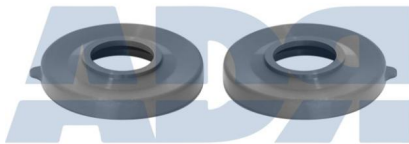

KIT REPARACION CALIPER

Ref.: 17M12120

Equivalente a:

Características:

DAF 2169213

- Lado de montaje: eje trasero
- Peso: 380 gr

MERITOR MCK1238, 68324854S2,
68324854PK10S2, 68324854PK10
S2, 68324854 S2

VOLVO 3092264, 3092272S2,
3092272 S2, 20777352S2, 20777352
S2, 20706973S2, 20706973 S2

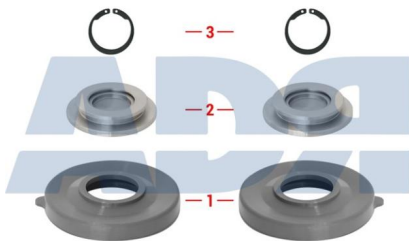

KIT AJUSTADOR IZQUIERDO C/LE DUCO

Ref.: 17M12130



KIT REPARACION CALIPER

Ref.: 17M12140

Equivalente a:

Características:

MERITOR MCK1237

- Lado de montaje: eje trasero
- Peso: 2320 gr

VOLVO 3092263



KIT PIÑÓN Y MUELLES D DUCO

Ref.: 17M12150

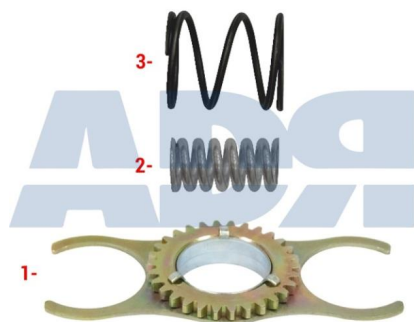

AJUSTADOR AUTO. TRAS. DCHO. D DUCO AXIAL

Ref.: 17M12180



AJUSTADOR AUTO. TRAS. IZQDO. D DUCO AXIAL

Ref.: 17M12190

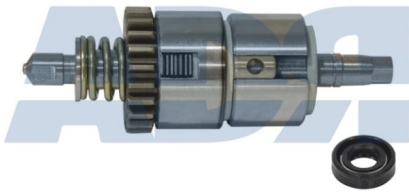

PLACA ANTIRROTACIÓN EMPUJADOR D-DUCO

Ref.: 17M12230



KIT SELLADO CUBIERTA D DUCO RADIAL

Ref.: 17M12240

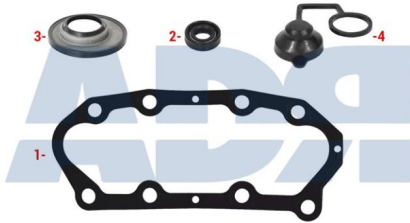

KIT SELLADO CUBIERTA D DUCO

Ref.: 17M12250



KIT TAPONES Y JUNTAS TAPA C/LE DUCO

Ref.: 17M12260

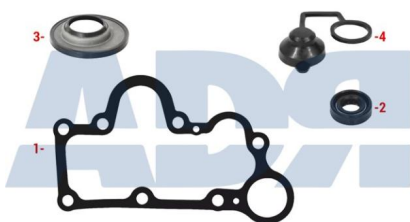

MECANISMO AJUSTE DERECHO C LISA

Ref.: 17M12320



KIT GUIAS Y CIERRE ELSA 2

Ref.: 17M12330

Características:

- Lado de montaje: eje trasero
- Peso: 2350 gr

Equivalente a:

IVECO 50 0186 0791, 5001860791

MAN 81.50802.6025, 81508026025

MERITOR MCK1243

RENAULT 50 01 860 791

VOLVO 85107912

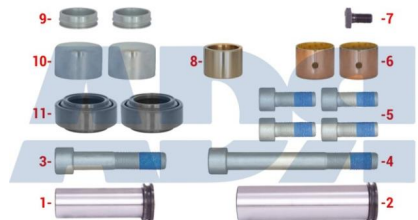

MECANISMO DE AJUSTE ELSA2

Ref.: 17M12340



KIT PIÑONES CALIBRACION ELSA 2

Ref.: 17M12350



MECANISMO CALIBRACION ELSA2

Ref.: 17M12351



MECANISMO CALIBRACION TAPA ALUMINIO ELSA 2

Ref.: 17M12360

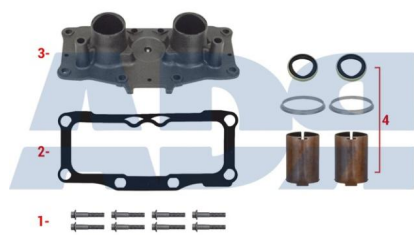

PIÑÓN ENGRANAJE IZQUIERDO ELSA 2

Ref.: 17M12370



PIÑÓN ENGRANAJE DERECHO ELSA 3

Ref.: 17M12380



COJINETE TAPA ELSA2

Ref.: 17M12400



KIT GUIAS Y RETENES MERITOR ELSA1

Ref.: 17M12410



KIT GUARDAPOLVOS ELSA 2

Ref.: 17M12420

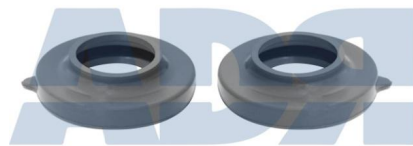

MECANISMO DE AJUSTE ELSA195/225

Ref.: 17M12930

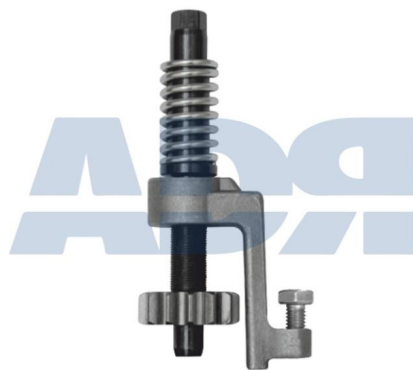

KIT TAPAS Y GUARDAPOLVOS ELSA2

Ref.: 17M12940

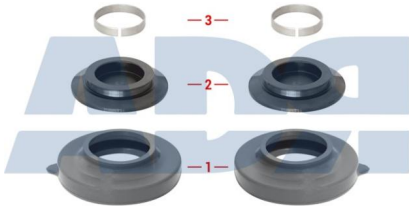

TAPA GUARDAPOLVOS ELSA2

Ref.: 17M12970



KIT RODAMIENTOS Y CASQUILLOS C LISA

Ref.: 17M12980



MECANISMO CALIBRACION TAPA ALUMINIO ELSA 195/225

Ref.: 17M12990

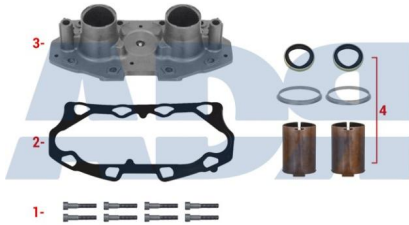

KIT GUARDAPOLVOS Y JUNTA D LISA

Ref.: 17M13000

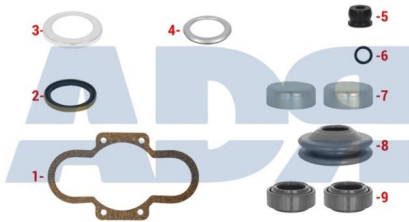

PUENTE DX195

Ref.: 17M13120

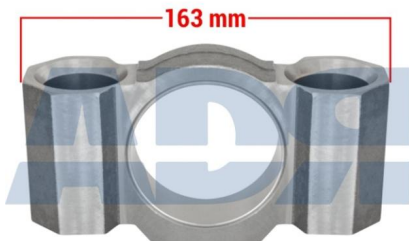

PUENTE DX225

Ref.: 17M13121

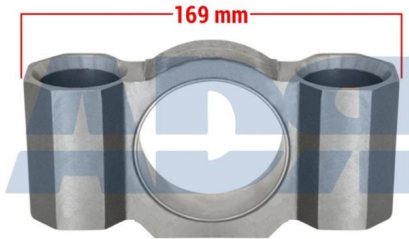

LEVA L123MM ELSA2 RADIAL/AXIAL

Ref.: 17M13130



JUNTA TAPA ELSA 1

Ref.: 17M13150

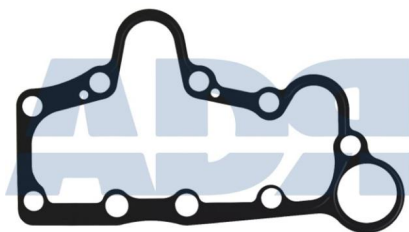

KIT REPARACION CALIPER

Ref.: 17M13230

Equivalente a:

Características:

IVECO 50 0185 8717, 5001858717

- Peso: 2144 gr

MERITOR MCK1086

RENAULT 50 01 858 717

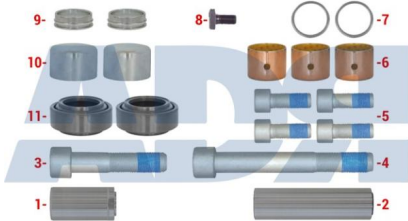

KIT EJE ACCIONAMIENTO IZQDO. MERITOR C LISA

Ref.: 17M13280

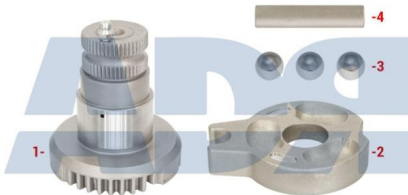

KIT JUNTAS AJUSTADOR ELSA195/225

Ref.: 17M13360



KIT GUIAS Y CIERRE ELSA195/225

Ref.: 17M13370

Equivalente a:

Características:

MAN ZG070160007, STRMCK1254

- Peso: 2050 gr

MERITOR MCK1254

VOLVO AMMCK1254

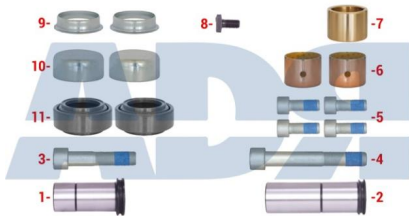

ARANDELA RETEN ELSA 2 RADIAL/AXIAL

Ref.: 17M13420

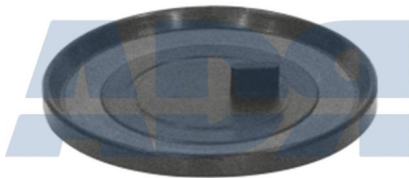

KIT RODAMIENTO AGUJA D DUCO RADIAL

Ref.: 17M13560

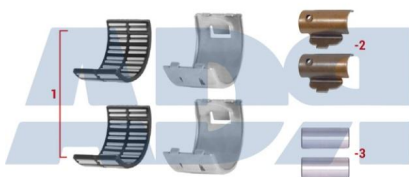

INDICADOR VISUAL D DUCO

Ref.: 17M13570

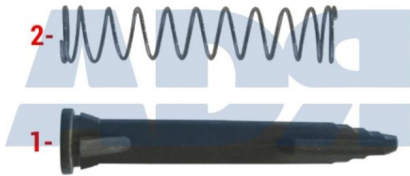

INDICADOR VISUAL ELSA195/225

Ref.: 17M13580

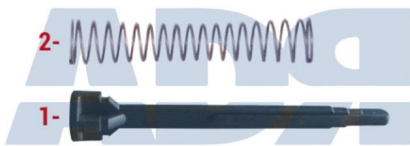

KIT TORNILLOS INDICADOR VISUAL ELSA2 RADIAL/AXIAL

Ref.: 17M13581

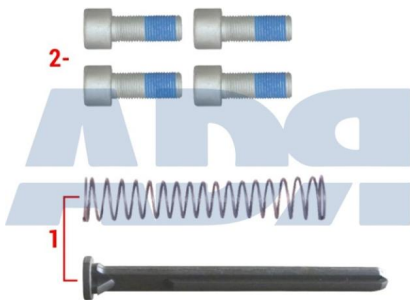

KIT PLACA EMPUJE DERECHA DX194

Ref.: 17M13600

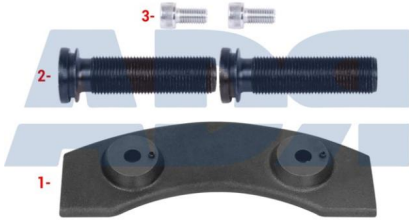

KIT PLACA EMPUJE IZQUIERDA DX195

Ref.: 17M13610

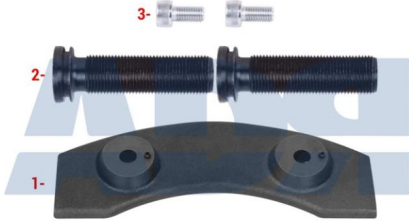

TAPA ALUMINIO ELSA2

Ref.: 17M13670

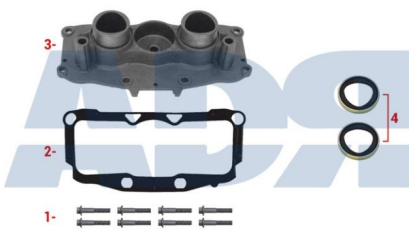

KIT GUIAS Y CIERRE ELSA2

Ref.: 17M13680

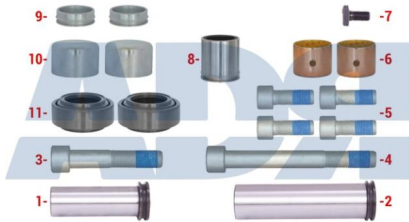

MECANISMO DE AJUSTE ELSA 2

Ref.: 17M13690

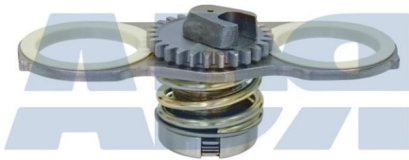

KIT ARANDELAS CENTRAJE DX195

Ref.: 17M14000

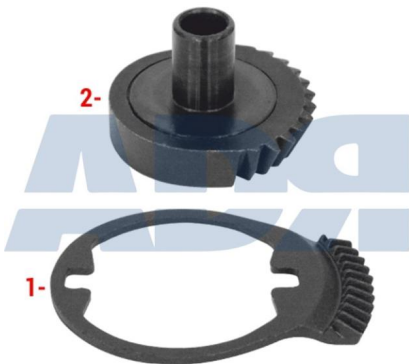



ADR

KIT ACC. PASTILLAS S/FLEJE ELSA 2

Ref.: 17M14010



KIT MECANISMO AJUSTE IZQUIERDO DX195

Ref.: 17M14020



KIT MECANISMO AJUSTE DERECHO DX195

Ref.: 17M14030



FLEJE RETENEDOR PASTILLAS DX195

Ref.: 17M14050



RODAMIENTO AGUJAS DX195

Ref.: 17M14120

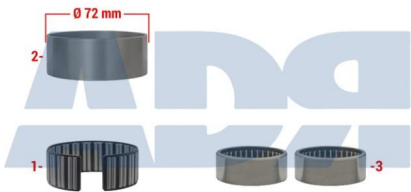

KIT PIÑÓN IZQUIERDO MERITOR D3

Ref.: 17M14130



KIT PIÑÓN DERECHO MERITOR D3

Ref.: 17M14140



KIT GUIAS Y CIERRE ELSA 195/225

Ref.: 17M14310

Equivalente a:

Características:

MERITOR MCK1317

- Peso: 2389 gr

VOLVO 85109889

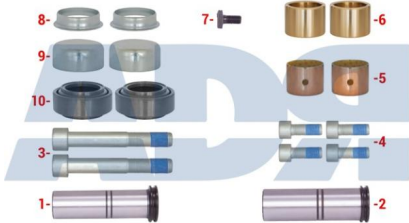

MECANISMO PINZA DERECHO ELSA1

Ref.: 17M14420



MECANISMO PINZA IZQUIERDO ELSA1

Ref.: 17M14430



KIT GUIAS Y CIERRE ELSA 195/225

Ref.: 17M14440

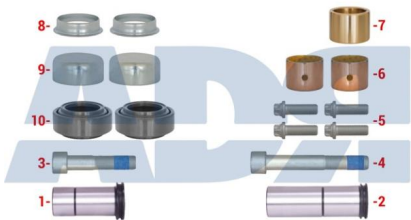

KIT GUIAS Y JUNTAS ELSA195/225 RADIAL/AXIAL

Ref.: 17M14460

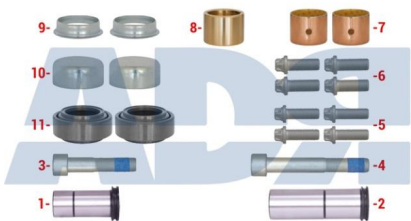



ADR

LEVA ELSA195/225 RADIAL AXIAL

Ref.: 17M14510



KIT ACC. PASTILLAS S/FLEJE D DUCO

Ref.: 17M14720



KIT ACCE. PASTILLA S/FLEJE ELSA 1

Ref.: 17M14730



KIT CASQUILLOS LEVA ELSA195/225

Ref.: 17M14870

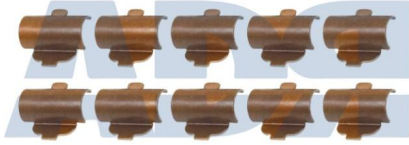

LEVA ELSA 195/225

Ref.: 17M14990



KIT MECANISMO DERECHO MERITOR DX225

Ref.: 17M18110

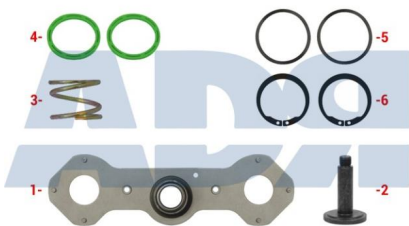

KIT MECANISMO IZQUIERDO MERITOR DX226

Ref.: 17M18120

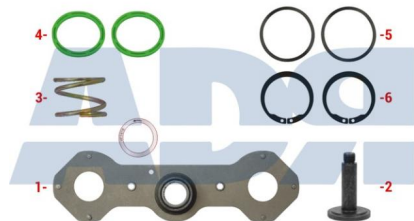

KIT REPARACION CALIPER

Ref.: 17M18440

Equivalente a:

Características:

MERITOR MCK1172

- Peso: 1760 gr

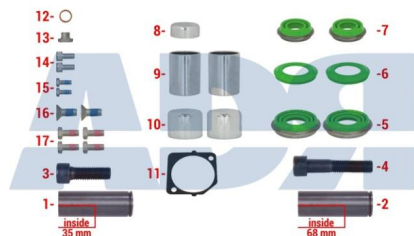

CASQUILLO ENGRANAJE Ø35MM ELSA 1

Ref.: 17M18830

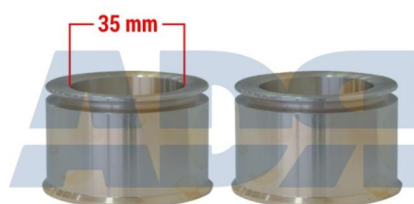

JUNTA TAPA DX225

Ref.: 17M18850



MECANISMO DE AJUSTE MERITOR B DUCO

Ref.: 17M18870

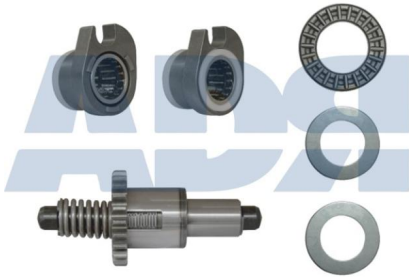

PLACA ANTI GIRO C/LE DUCO

Ref.: 17M18880

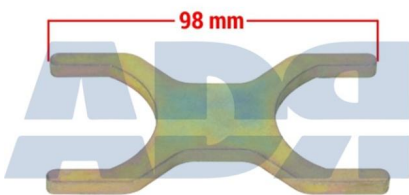

KIT REPARACION CALIPER

Ref.: 17M19010

Equivalente a:

Características:

MERITOR MCK1066, MCK1299

- Lado de montaje: eje trasero
- Peso: 1489,500 gr

VOLVO 3092268, 3095628, 3096769,
85107718

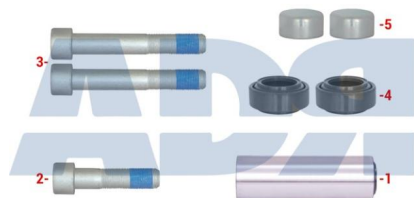

KIT REPARACION CALIPER

Ref.: 17M19120

Equivalente a:

Características:

MERITOR MCK1169, MCK1168,
MCK1294

- Peso: 2360 gr



PORTA PINZA D DUCO 19

Ref.: 17M19750

Equivalente a:

MERITOR 68323539

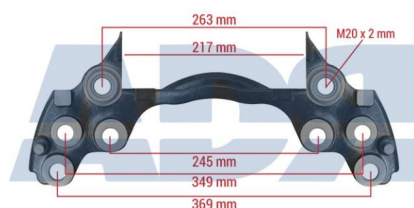

PORTA PINZA ELSA 195/225 (VOLVO) C/PIN

Ref.: 17M19870

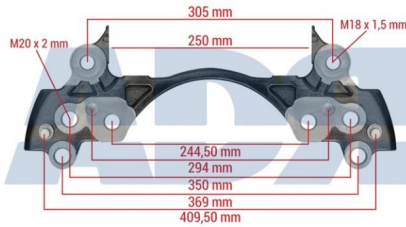

KIT (8) TORNILLOS M14X1,5X55MM D DUCO

Ref.: 17M19890

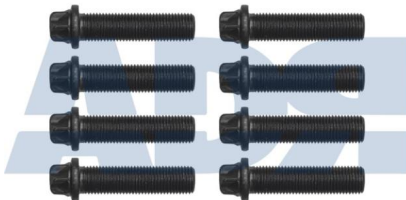

PORTA PINZA MERITOR ELSA 195/225 (RENAULT 440)

Ref.: 17M19930

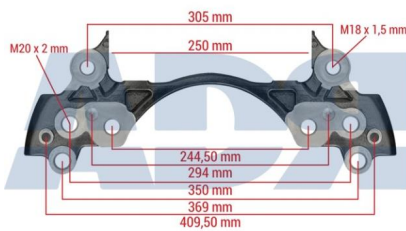

PORTA PINZA DX195

Ref.: 17M21260

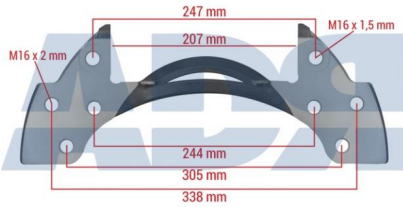

LEVA CALIPER ELSA 2 (CON PIN IVECO)

Ref.: 17M21990



PORTA PPINZA D DUCO 22,5

Ref.: 17M22280



SOPORTE PINZA DX225 DERECHA

Ref.: 17M22510



SOPORTE PINZA DX225 IZQUIERDA

Ref.: 17M22520



PORTA PINZA ELSA 195/225 (VOLVO FH16)

Ref.: 17M22760

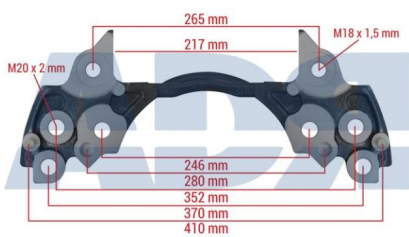



ADR

PORTA PINZA LRG730/LRG731

Ref.: 17M24250



ARCO CALIPER ELSA 195 VOLVO

Ref.: 17M24270



KIT REPARACION CALIPER

Ref.: 17M85640

Características:

- Peso: 78 gr

Equivalente a:

IVECO 9316 1552, 93161552

MERITOR SP8564

VOLVO 3090937





ADR

CASQUILLO FIBRA 45X49X30 MERITOR

Ref.: 17M95320



KIT REPARACION CALIPER

Ref.: 17M96700

Características:

- Peso: 175 gr

Equivalente a:

DAF 1522163

MERITOR SP9670

VOLVO 3090940



RETEN WABCO PAN17

Ref.: 17W08552

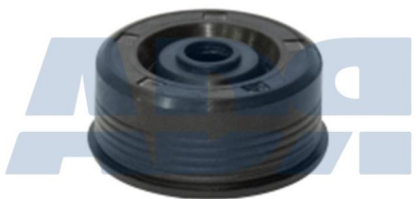



ADR

KIT RETENES (10) CALIPER W MAXX, PAN, 1000/1300

Ref.: 17W10960



KIT GUIAS Y RETENES WABCO PAN17

Ref.: 17W12430



KIT GUARDAPOLVOS W PAN-17

Ref.: 17W12440



RODAMIENTO AGUJAS WABCO PAN17



Ref.: 17W12480

Características:

- Peso: 60 gr

Equivalente a:

ISUZU 3777773996

LEVA C/PASADOR WABCO PAN 17

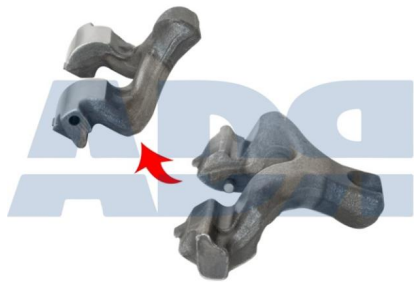

Ref.: 17W12490

KIT JUNTAS Y RETENES WABCO PAN17

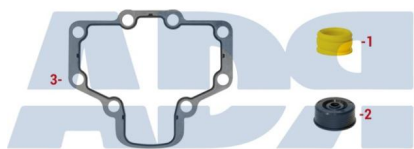

Ref.: 17W12500

PLACA PRESION IZQUIERDA C/RANURA PAN17

Ref.: 17W12510



PLACA PRESION DERECHA C/RANURA PAN17

Ref.: 17W12520



KIT GUIAS Y RETENES WABCO PAN19-1, PAN22-1

Ref.: 17W12550

Características:

- Peso: 2140 gr

Equivalente a:

DAF 1505890

SAF 03434382700, 3434382701,
3434382700, 03434382701

SCHMITZ CARGOBULL 1020777

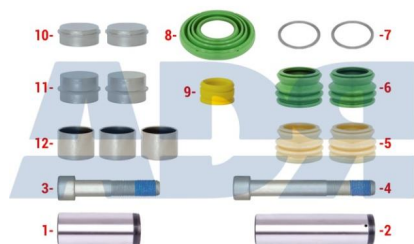

KIT GUIAS Y JUNTAS WABCO PAN19-1, PAN22-1

Ref.: 17W12560

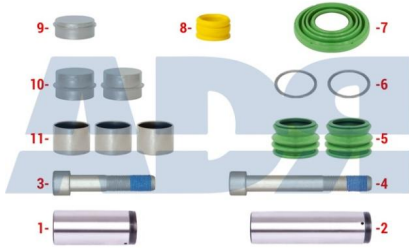

PLACA PRESION IZQUIERDA C/RANURA PAN19-1, PAN22-1

Ref.: 17W12580



PLACA PRESION DERECHA C/RANURA PAN19-1, PAN22-1

Ref.: 17W12590



KIT JUNTAS Y RETENES WABCO PAN19-1 / PAN22-1

Ref.: 17W12600



PLACA PRESION IZQUIERDA C/RANURA PAN19-1, PAN22-1

Ref.: 17W12610



PLACA PRESION DERECHA C/RANURA PAN19-1, PAN22-1

Ref.: 17W12620



BULON REGULACION C/PIN LARGO PAN19-1, PAN22-1

Ref.: 17W12660



KIT GUIAS Y CIERRE WABCO PAN19-2, PAN22-2

Ref.: 17W12710

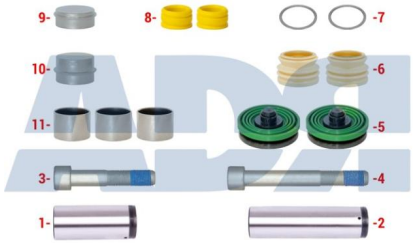

KIT GUIAS Y JUNTAS PAN19-2, PAN22-2

Ref.: 17W12720

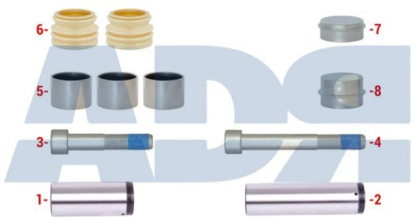

KIT EMPUJADORES PAN19-2; PAN22-2

Ref.: 17W12730



BULON CALIBRACION IZQUIERDO PAN19-2, PAN22-2

Ref.: 17W12750



BULON CALIBRACION DERECHO PAN19-2, PAN22-2

Ref.: 17W12760



SOPORTE MECANISMO AJUSTE MONTADO WABCO PAN17

Ref.: 17W13320



SOPORTE MECANISMO AJUSTE MONTADO PAN19-1, PAN22-1

Ref.: 17W13330



JUNTA TAPA PAN19-2, PAN22-2

Ref.: 17W13440

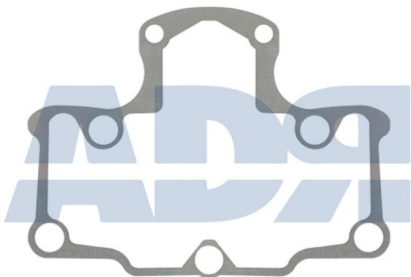

RODAMIENTO AGUJAS WABCO PAN19-2, PAN22-2

Ref.: 17W13660



KIT GUIAS Y RETENES WABCO 1000 V-G

Ref.: 17W13700

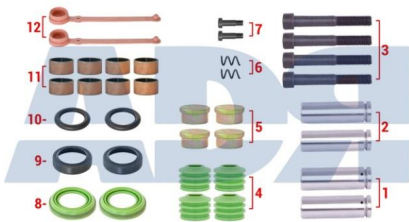

KIT FIJACION PASTILLAS DE FRENO PAN19-1, PAN22-1

Ref.: 17W14270

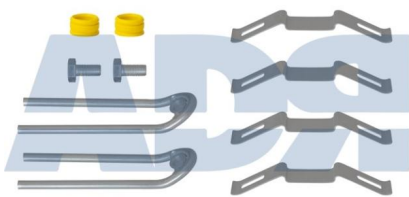

KIT FIJACION PASTILLAS WABCO PAN19-2, PAN22-2

Ref.: 17W14280

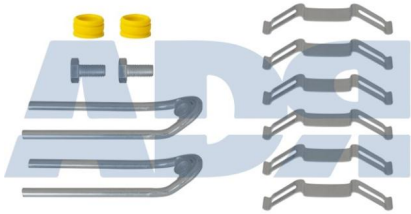

KIT FIJACION PASTILLAS DE FRENO PAN19-1, PAN22-1

Ref.: 17W14290

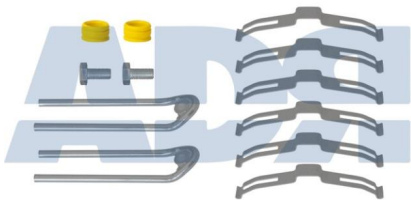

KIT FIJACION PASTILLAS DE FRENO PAN17

Ref.: 17W14300

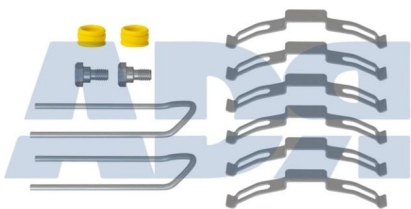



ADR

KIT REPARACION GUIAS Y JUNTAS PAN19-2 / PAN22-2

Ref.: 17W14500



PLACA PRESION DERECHA C/RANURA PAN19-1, PAN22-1

Ref.: 17W18020

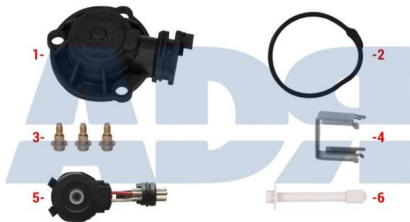

LEVA DE AJUSTE WABCO PAN19-2, PAN22-2

Ref.: 17W18200

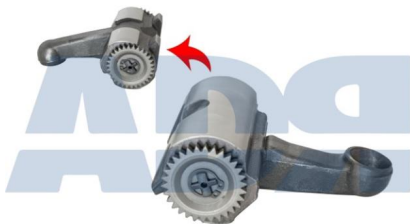

LEVA CON PIN MAXX22

Ref.: 17W18470

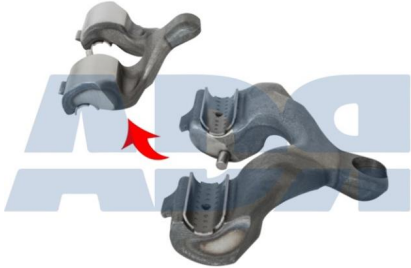

RODAMIENTO AGUJAS WABCO MAXX 22

Ref.: 17W18500



KIT RODAMIENTO AGUJA MAXX 22

Ref.: 17W18510



KIT GUIAS Y SELLADO WABCO MAXX 22

Ref.: 17W18560

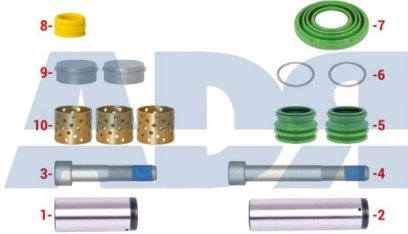

PLACA PRESION DERECHA C/RANURA WABCO MAXX 22

Ref.: 17W18760



PLACA PRESION IZQUIERDA C/RANURA MAXX 22

Ref.: 17W18770



CASQUILLO MECANISMO WABCO PAN19-2

Ref.: 17W18780

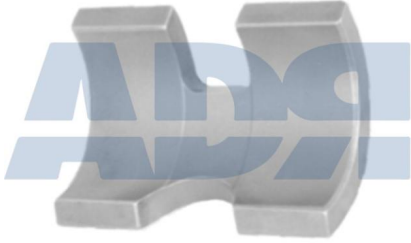

PLACA PRESION IZQUIERDA C/RANURA PAN19-1, PAN22-1

Ref.: 17W19390



KIT REPARACION SELLADO WABCO 1300V-G

Ref.: 17W19400





ADR

PORTA PINZA 17,5" DERECHO MAN

Ref.: 17W19570



PORTA PINZA WABCO 17' IZQUIERDO

Ref.: 17W19580

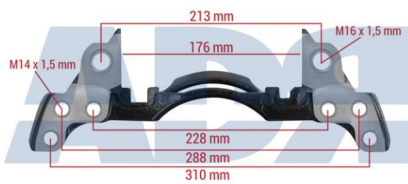

KIT FIJACION PASTILLAS DE FRENO MAXX 22

Ref.: 17W19730

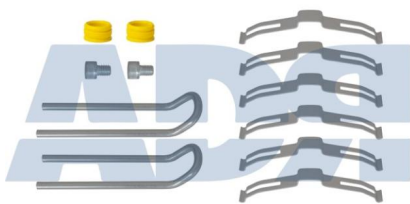

PORTA PINZA WABCO PAN22 DERECHA

Ref.: 17W21210

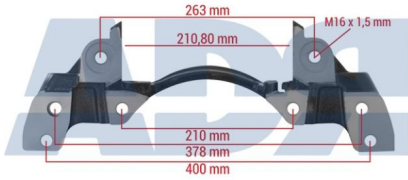

PORTA PINZA WABCO PAN22 IZQUIERDO

Ref.: 17W21220

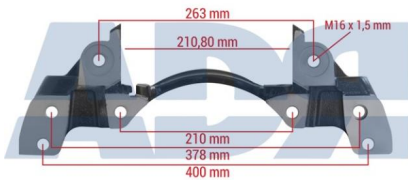

PORTA PINZA WABCO 19,5' DERECHO

Ref.: 17W21770

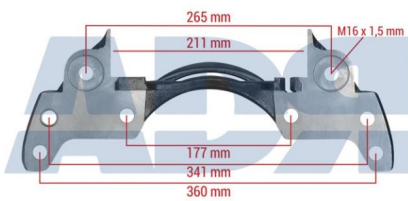

PORTA PINZA WABCO 19,5' IZQUIERDO

Ref.: 17W21780

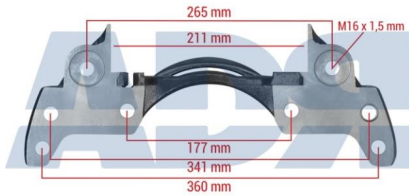

EJE CALIBRADOR DERECHO WABCO 1300V-G

Ref.: 17W21900



EJE PINZA LADO IZQUIERDO WABCO 1300V-G

Ref.: 17W21910



CJTO. PISTON DERECHO Ø58 X 63,60 MM WABCO 1300V-G

Ref.: 17W21920



CJTO. PISTON IZQUIERDO Ø58 X 63,60 MM WABCO 1300V-G

Ref.: 17W21940



PORTA PINZA WABCO VALX IZQUIERDO

Ref.: 17W22180

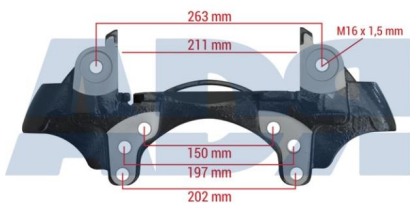

KIT GUIAS Y JUNTAS WABCO MAXX 22T

Ref.: 17W22200

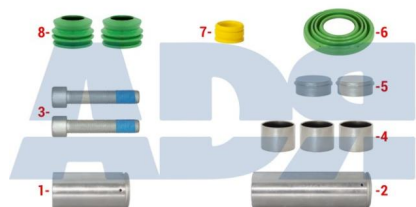

SOPORTE MECANISMO AJUSTE MONTADO WABCO MAXX 22T

Ref.: 17W22210



LEVA C/PIN WABCO MAXX 22T

Ref.: 17W22220



TAPA CALIPER MAXX 22T

Ref.: 17W22230



KIT GUIAS Y CIERRE WABCO PAN19-1, PAN22-1

Ref.: 17W22270

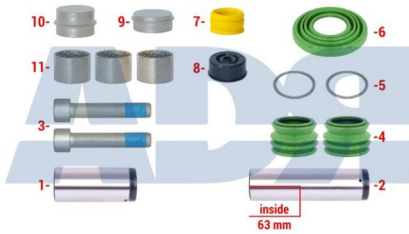

MECANISMO AJUSTE MAXX 22 (MAN TGS)

Ref.: 17W22320



KIT GUIAS Y JUNTAS W MAXX 17

Ref.: 17W24310

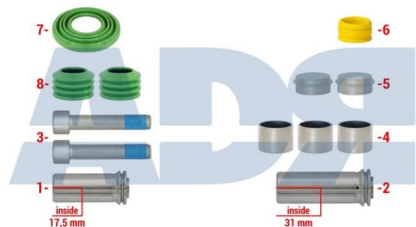

MECANISMO AJUSTE W MAXX 17

Ref.: 17W24320



LEVA CON PIN W MAXX 19

Ref.: 17W24480

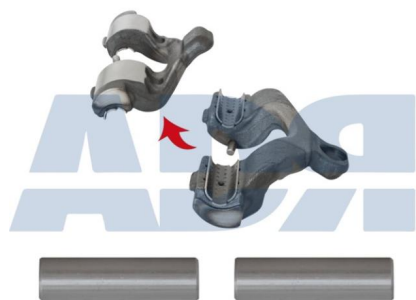



ADR

TAPA CALIPER W MAXX19/22T (SCHMITZ SCB430W1)

Ref.: 17W24500

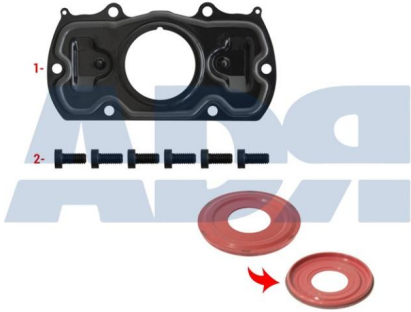

KIT GUARDAPOLVOS W MAXX 19

Ref.: 17W24520



MECANISMO DE REPARACION W MAXX 19

Ref.: 17W24530





ADR

KIT GUIAS Y JUNTAS W MAXX 19

Ref.: 17W24610



MECANISMO DE AJUSTE W MAXX19

Ref.: 17W24620



CASQUILLO TAPA CALIPER MAXX17

Ref.: 17W30500





ADR

LEVA CALIPER C/PIN MAXX 17

Ref.: 17W30530



MECANISMO DE AJUSTE MAXX17 CWS

Ref.: 17W30590



MECANISMO DE AJUSTE MAXX 19

Ref.: 17W30610

